



Ultralow-Noise, High-PSRR, Fast, RF, 1-A LOW-DROPOUT LINEAR REGULATORS

Check for Samples: [TPS796xx-Q1](#)

FEATURES

- Qualified for Automotive Applications
- AEC-Q100 Test Guidance With the Following Results:
 - Device Temperature Grade 1: –40°C to 125°C Ambient Operating Temperature Range
 - Device HBM ESD Classification Level H2
 - Device CDM ESD Classification Level C3A
- 1-A Low-Dropout Regulator With Enable
- Available in Fixed and Adjustable (1.2 V to 5.5 V) Versions
- High PSRR (53 dB at 10 kHz)
- Ultralow-Noise (40 μV_{RMS} , TPS79630-Q1)
- Fast Start-Up Time (50 μs)
- Stable With a 1- μF Ceramic Capacitor
- Excellent Load/Line Transient Response
- Very Low Dropout Voltage (250 mV at Full Load, TPS79630-Q1)
- SOT223-6 Package

APPLICATIONS

- RF: VCOs, Receivers, ADCs
- Audio
- Bluetooth™, Wireless LAN

DESCRIPTION

The TPS796xx-Q1 family of low-dropout (LDO), low-power, linear voltage regulators features high power-supply rejection ratio (PSRR), ultralow-noise, fast start-up, and excellent line and load transient responses in a small-outline SOT223-6 package. Each device in the family is stable with a small 1- μF ceramic capacitor on the output. The family uses an advanced, proprietary BiCMOS fabrication process to yield extremely low dropout voltages (for example, 250 mV at 1 A). Each device achieves fast start-up times (approximately 50 μs with a 0.001- μF bypass capacitor) while consuming very low quiescent current (265 μA typical). Moreover, when the device is placed in standby mode, the supply current is reduced to less than 1 μA . The TPS79630-Q1 exhibits approximately 40 μV_{RMS} of output voltage noise at 3-V output, with a 0.1- μF bypass capacitor. Applications with analog components that are noise-sensitive, such as portable RF electronics, benefit from the high-PSRR, low-noise features and the fast response time.

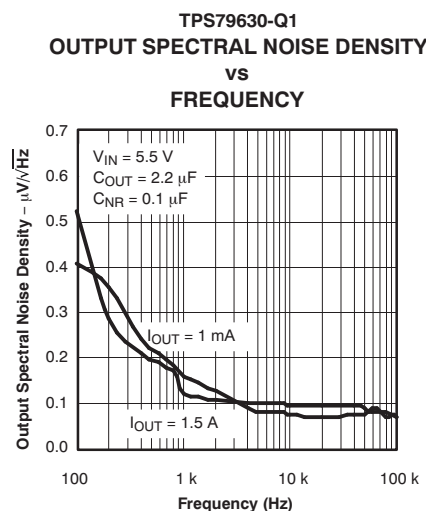
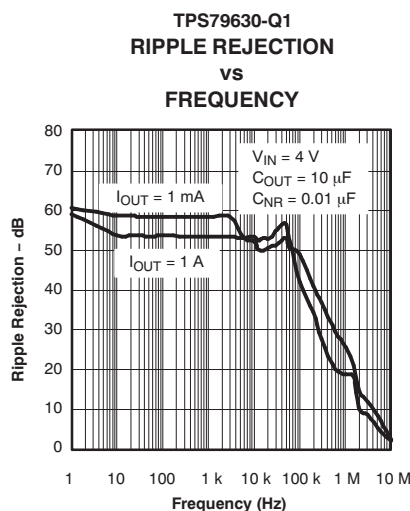
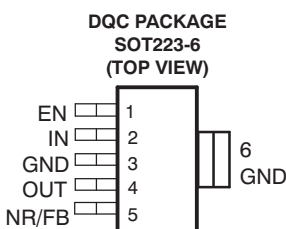

Please be aware that an important notice concerning availability, standard warranty, and use in critical applications of Texas Instruments semiconductor products and disclaimers thereto appears at the end of this data sheet.

Bluetooth is a trademark of Bluetooth SIG, Inc.

All other trademarks are the property of their respective owners.

UNLESS OTHERWISE NOTED this document contains PRODUCTION DATA information current as of publication date. Products conform to specifications per the terms of Texas Instruments standard warranty. Production processing does not necessarily include testing of all parameters.



This integrated circuit can be damaged by ESD. Texas Instruments recommends that all integrated circuits be handled with appropriate precautions. Failure to observe proper handling and installation procedures can cause damage.

ESD damage can range from subtle performance degradation to complete device failure. Precision integrated circuits may be more susceptible to damage because very small parametric changes could cause the device not to meet its published specifications.

ORDERING INFORMATION⁽¹⁾

PRODUCT	SPECIFIED TEMPERATURE RANGE, T _A	PACKAGE TYPE, PACKAGE DESIGNATOR ⁽²⁾	PACKAGE MARKING	ORDERING NUMBER	TRANSPORT MEDIA, QUANTITY
TPS79633-Q1	–40°C to +125°C	SOT223-6, DCQ	79633Q	TPS79633QDCQRQ1	Reel, 2500
TPS79630-Q1	–40°C to 125°C	SOT223-6, DCQ	PREVIEW	TPS79630QDCQRQ1	Reel, 2500
TPS79625-Q1	–40°C to 125°C	SOT223-6, DCQ	PREVIEW	TPS79625QDCQRQ1	Reel, 2500
TPS79628-Q1	–40°C to 125°C	SOT223-6, DCQ	PREVIEW	TPS79628QDCQRQ1	Reel, 2500

- (1) For the most current package and ordering information, see the Package Option Addendum at the end of this document, or see the TI web site at www.ti.com.
- (2) Package drawings, thermal data, and symbolization are available at www.ti.com/packaging.

ABSOLUTE MAXIMUM RATINGS⁽¹⁾

Over operating temperature range (unless otherwise noted).

		UNIT
V _{IN} range		–0.3 V to 6 V
V _{EN} range		–0.3 V to V _{IN} + 0.3 V
V _{OUT} range		6 V
Peak output current		Internally limited
Continuous total power dissipation		See Thermal Information table
ESD ratings	Human Body Model (HBM) AEC-Q100 Classification Level H2	2 kV
	Charged Device Model (CDM) AEC-Q100 Classification Level C3A	500 V

- (1) Stresses beyond those listed under *absolute maximum ratings* may cause permanent damage to the device. These are stress ratings only, and functional operation of the device at these or any other conditions beyond those indicated under *recommended operating conditions* is not implied. Exposure to absolute-maximum-rated conditions for extended periods may affect device reliability.

RECOMMENDED OPERATING CONDITIONS

Over operating free-air temperature range (unless otherwise noted).

	MIN	NOM	MAX	UNIT
Ambient temperature, T_A	-40°		125	°C

THERMAL INFORMATION

THERMAL METRIC ⁽¹⁾⁽²⁾		TPS796xx-Q1	
		DCQ	
		6 PINS	
			UNIT
θ_{JA}	Junction-to-ambient thermal resistance	70.4	°C/W
θ_{JCTop}	Junction-to-case (top) thermal resistance	70	°C/W
θ_{JB}	Junction-to-board thermal resistance	N/A	°C/W
ψ_{JT}	Junction-to-top characterization parameter	6.8	°C/W°
ψ_{JB}	Junction-to-board characterization parameter	30.1	°C/W
θ_{JCbott}	Junction-to-case (bottom) thermal resistance	6.3	°C/W

- (1) For more information about traditional and new thermal metrics, see the *IC Package Thermal Metrics* application report, [SPRA953A](#).
 (2) For thermal estimates of this device based on PCB copper area, see the [TI PCB Thermal Calculator](#).

ELECTRICAL CHARACTERISTICS

Over recommended operating temperature range ($T_A = -40^\circ\text{C}$ to 125°C), $V_{EN} = V_{IN}$, $V_{IN} = V_{OUT(nom)} + 1\text{ V}^{(1)}$, $I_{OUT} = 1\text{ mA}$, $C_{OUT} = 10\text{ }\mu\text{F}$, and $C_{NR} = 0.01\text{ }\mu\text{F}$, unless otherwise noted. Typical values are at $+25^\circ\text{C}$.

PARAMETER			TEST CONDITIONS	MIN	TYP	MAX	UNIT
V_{IN} Input voltage ⁽¹⁾				2.7		5.5	V
I_{OUT} Continuous output current				0		1	A
Output voltage	Accuracy	Fixed $V_{OUT} < 5\text{ V}$	$0\text{ }\mu\text{A} \leq I_{OUT} \leq 1\text{ A}$, $V_{OUT} + 1\text{ V} \leq V_{IN} \leq 5.5\text{ V}^{(1)}$	-2.0		+2.0	%
Output voltage line regulation ($\Delta V_{OUT}\%/V_{IN}$) ⁽¹⁾			$V_{OUT} + 1\text{ V} \leq V_{IN} \leq 5.5\text{ V}$		0.05	0.12	%/V
Load regulation ($\Delta V_{OUT}\%/\Delta I_{OUT}$)			$0\text{ }\mu\text{A} \leq I_{OUT} \leq 1\text{ A}$		5		mV
Dropout voltage ⁽²⁾ ($V_{IN} = V_{OUT(nom)} - 0.1\text{ V}$)	TPS79628-Q1		$I_{OUT} = 1\text{ A}$		270	365	mV
	TPS79630-Q1		$I_{OUT} = 1\text{ A}$		250	345	mV
	TPS79633-Q1		$I_{OUT} = 1\text{ A}$		220	325	mV
Output current limit			$V_{OUT} = 0\text{ V}$	2.4		4.2	A
Ground pin current			$0\text{ }\mu\text{A} \leq I_{OUT} \leq 1\text{ A}$		265	385	μA
Shutdown current ⁽³⁾			$V_{EN} = 0\text{ V}$, $2.7\text{ V} \leq V_{IN} \leq 5.5\text{ V}$		0.07	1	μA
FB pin current			$V_{FB} = 1.225\text{ V}$			1	μA
Power-supply ripple rejection	TPS79630-Q1		$f = 100\text{ Hz}$, $I_{OUT} = 10\text{ mA}$		59		dB
			$f = 100\text{ Hz}$, $I_{OUT} = 1\text{ A}$		54		dB
			$f = 10\text{ Hz}$, $I_{OUT} = 1\text{ A}$		53		dB
			$f = 100\text{ Hz}$, $I_{OUT} = 1\text{ A}$		42		dB
Output noise voltage (TPS79630-Q1)			$BW = 100\text{ Hz to }100\text{ kHz}$, $I_{OUT} = 1\text{ A}$	$C_{NR} = 0.001\text{ }\mu\text{F}$		54	μV_{RMS}
				$C_{NR} = 0.0047\text{ }\mu\text{F}$		46	μV_{RMS}
				$C_{NR} = 0.01\text{ }\mu\text{F}$		41	μV_{RMS}
				$C_{NR} = 0.1\text{ }\mu\text{F}$		40	μV_{RMS}
Time, start-up (TPS79630-Q1)			$R_L = 3\text{ }\Omega$, $C_{OUT} = 1\text{ }\mu\text{F}$	$C_{NR} = 0.001\text{ }\mu\text{F}$		50	μs
				$C_{NR} = 0.0047\text{ }\mu\text{F}$		75	μs
				$C_{NR} = 0.01\text{ }\mu\text{F}$		110	μs
EN pin current			$V_{EN} = 0\text{ V}$	-1		1	μA
UVLO threshold			V_{CC} rising	2.25		2.65	V
UVLO hysteresis					100		mV
High-level enable input voltage			$2.7\text{ V} \leq V_{IN} \leq 5.5\text{ V}$	1.7		V_{IN}	V
Low-level enable input voltage			$2.7\text{ V} \leq V_{IN} \leq 5.5\text{ V}$	0		0.7	V

(1) Minimum $V_{IN} = V_{OUT} + V_{DO}$ or 2.7 V , whichever is greater. TPS79650-Q1 is tested at $V_{IN} = 5.5\text{ V}$.

(2) V_{DO} is not measured for TPS79625-Q1 because minimum $V_{IN} = 2.7\text{ V}$.

(3) For adjustable version, this applies only after V_{IN} is applied; then V_{EN} transitions high to low.

FUNCTIONAL BLOCK DIAGRAM

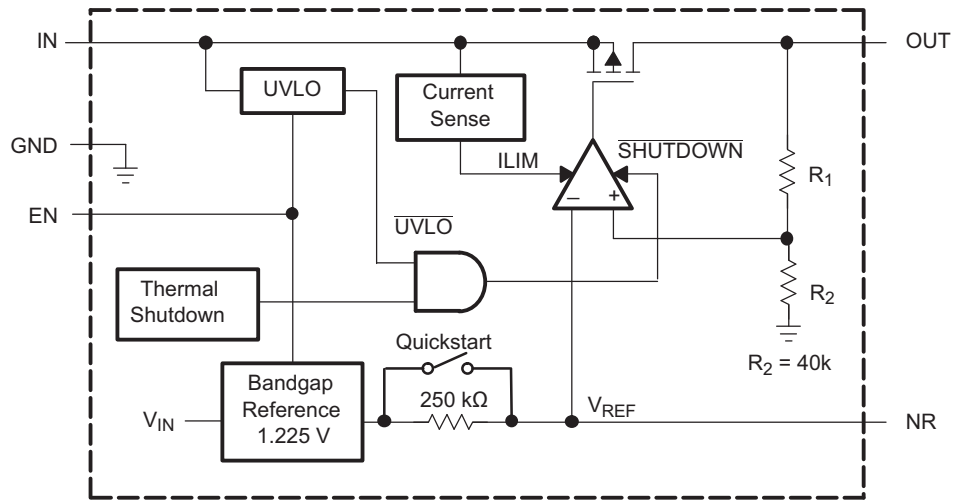

Table 1. Terminal Functions

TERMINAL		DESCRIPTION
NAME	SOT223 (DCQ)	
NR	5	Connecting an external capacitor to this pin bypasses noise generated by the internal bandgap. This improves power-supply rejection and reduces output noise.
FB	5	This terminal is the feedback input voltage for the adjustable device.
EN	1	Driving the enable pin (EN) high turns on the regulator. Driving this pin low puts the regulator into shutdown mode. EN can be connected to IN if not used.
GND	3, Tab	Regulator ground
IN	2	Unregulated input to the device.
OUT	4	Output of the regulator.

TYPICAL CHARACTERISTICS

**TPS79630-Q1
OUTPUT VOLTAGE
vs
OUTPUT CURRENT**

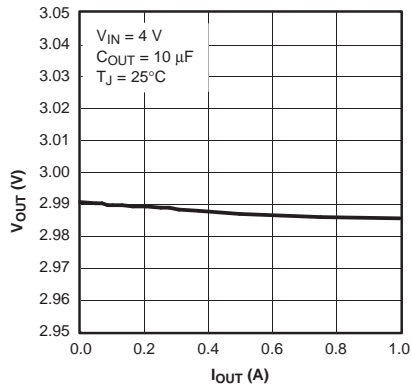

Figure 1.

**TPS79628-Q1
OUTPUT VOLTAGE
vs
JUNCTION TEMPERATURE**

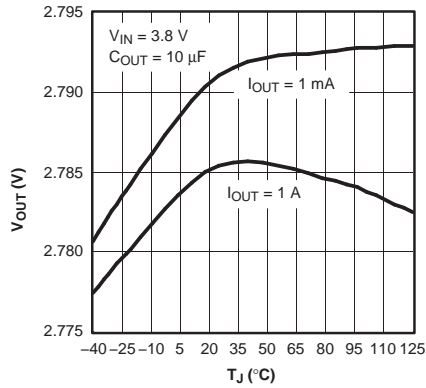

Figure 2.

**TPS79628-Q1
GROUND CURRENT
vs
JUNCTION TEMPERATURE**

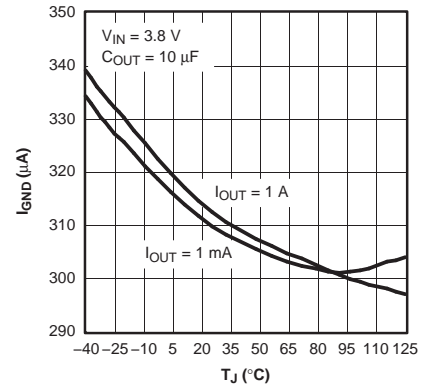

Figure 3.

**TPS79630-Q1
OUTPUT SPECTRAL NOISE DENSITY
vs
FREQUENCY**

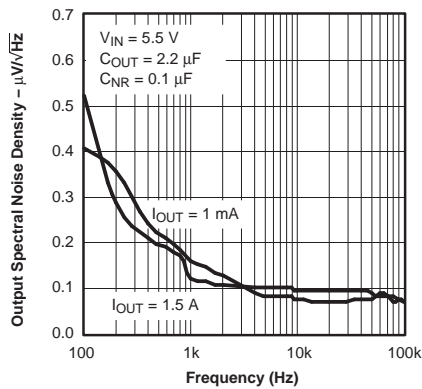

Figure 4.

**TPS79630-Q1
OUTPUT SPECTRAL NOISE DENSITY
vs
FREQUENCY**

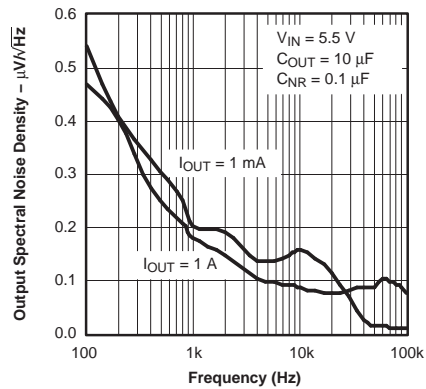

Figure 5.

**TPS79630-Q1
OUTPUT SPECTRAL NOISE DENSITY
vs
FREQUENCY**

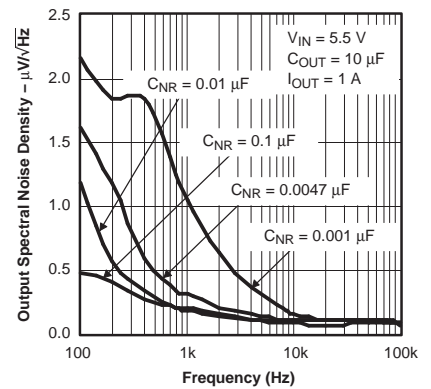

Figure 6.

TYPICAL CHARACTERISTICS (continued)

**TPS79630-Q1
ROOT MEAN SQUARED OUTPUT NOISE
vs
BYPASS CAPACITANCE**

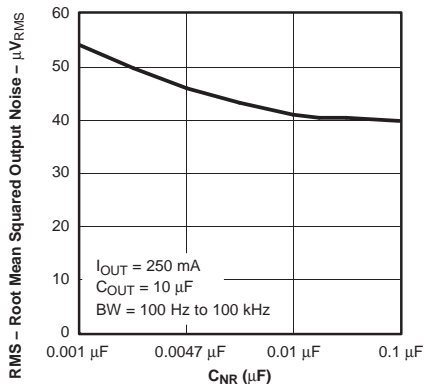

Figure 7.

**TPS79628-Q1
DROPOUT VOLTAGE
vs
JUNCTION TEMPERATURE**

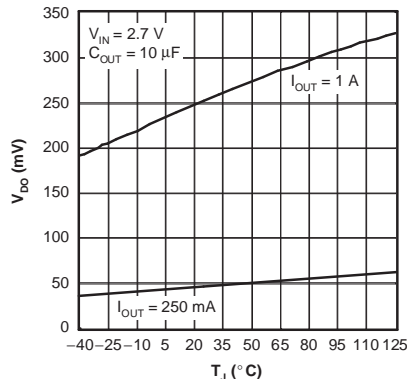

Figure 8.

**TPS79630-Q1
RIPPLE REJECTION
vs
FREQUENCY**

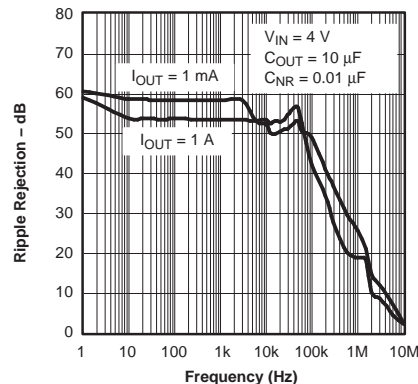

Figure 9.

**TPS79630-Q1
RIPPLE REJECTION
vs
FREQUENCY**

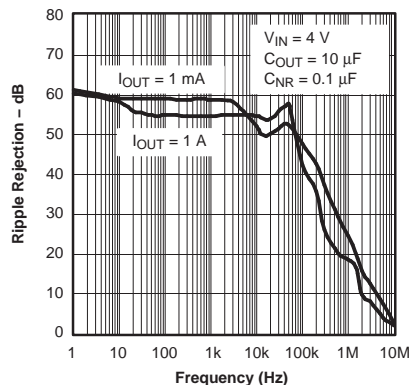

Figure 10.

**TPS79630-Q1
RIPPLE REJECTION
vs
FREQUENCY**

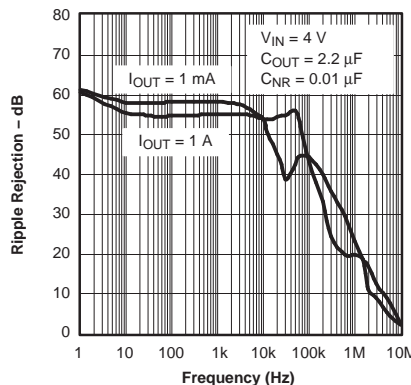

Figure 11.

START-UP TIME

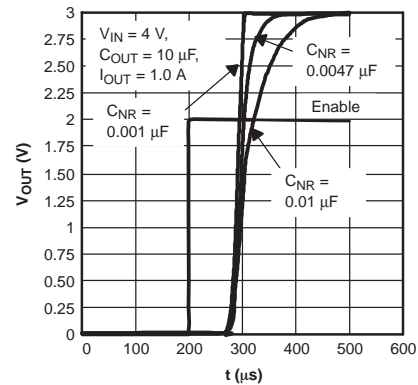

Figure 12.

**TPS79618-Q1
LINE TRANSIENT RESPONSE**

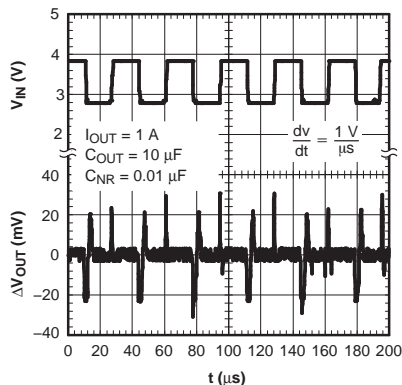

Figure 13.

**TPS79630-Q1
LINE TRANSIENT RESPONSE**

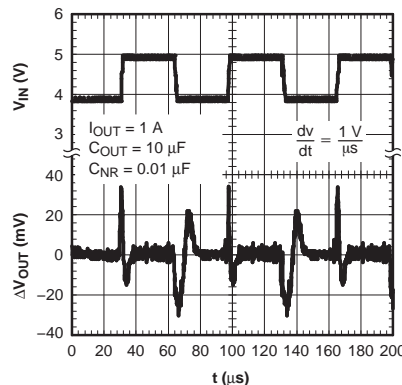

Figure 14.

**TPS79628-Q1
LOAD TRANSIENT RESPONSE**

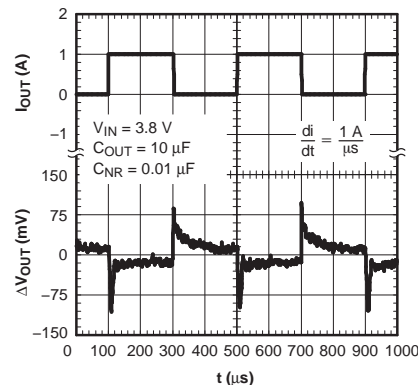

Figure 15.

TYPICAL CHARACTERISTICS (continued)

TPS79625-Q1

POWER UP/POWER DOWN

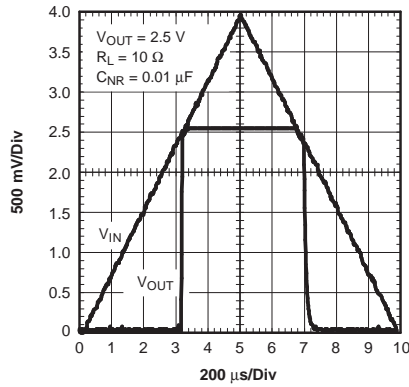

Figure 16.

TPS79630-Q1
DROPOUT VOLTAGE
vs
OUTPUT CURRENT

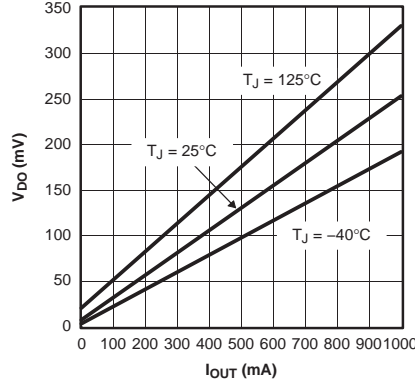

Figure 17.

TPS79630-Q1
TYPICAL REGIONS OF STABILITY
EQUIVALENT SERIES RESISTANCE
(ESR)
vs
OUTPUT CURRENT

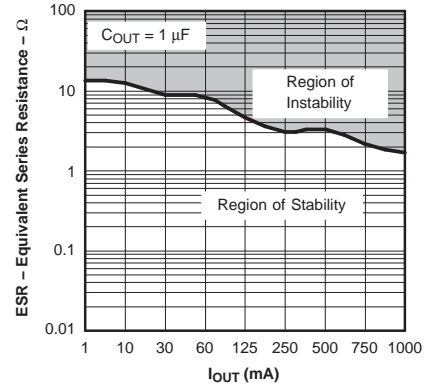

Figure 18.

TPS79630-Q1
TYPICAL REGIONS OF STABILITY EQUIVALENT SERIES
RESISTANCE (ESR)
vs
OUTPUT CURRENT

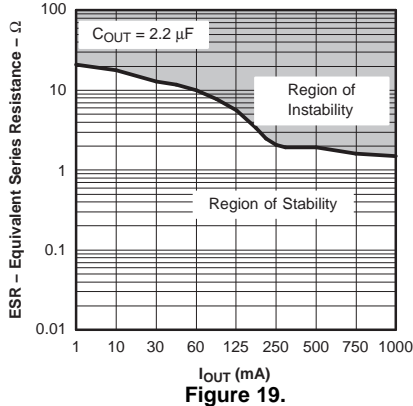

Figure 19.

TPS79630-Q1
TYPICAL REGIONS OF STABILITY EQUIVALENT SERIES
RESISTANCE (ESR)
vs
OUTPUT CURRENT

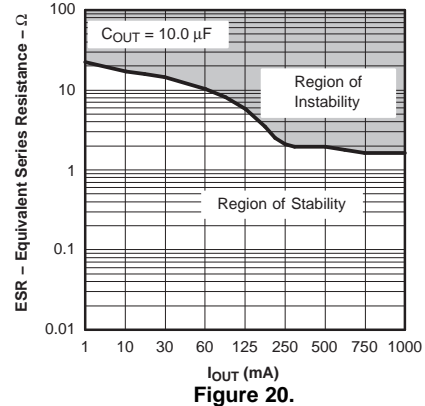

Figure 20.

APPLICATION INFORMATION

The TPS796xx-Q1 family of low-dropout (LDO) regulators has been optimized for use in noise-sensitive equipment. The device features extremely low dropout voltages, high PSRR, ultralow output noise, low quiescent current (265 μA typically), and enable input to reduce supply currents to less than 1 μA when the regulator is turned off.

A typical application circuit is shown in [Figure 21](#).

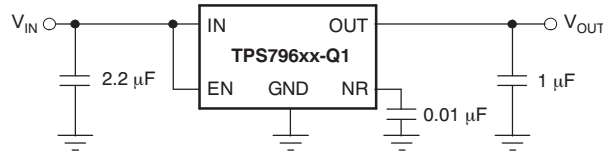

Figure 21. Typical Application Circuit

External Capacitor Requirements

Although not required, it is good analog design practice to place a 0.1- μF to 2.2- μF capacitor near the input of the regulator to counteract reactive input sources. A 2.2- μF or larger ceramic input bypass capacitor, connected between IN and GND and located close to the TPS796xx-Q1, is required for stability and improves transient response, noise rejection, and ripple rejection. A higher-value input capacitor may be necessary if large, fast-rise-time load transients are anticipated and the device is located several inches from the power source.

As with most LDO regulators, the TPS796xx-Q1 requires an output capacitor connected between OUT and GND to stabilize the internal control loop. The minimum recommended capacitor is 1 μF . Any 1- μF or larger ceramic capacitor is suitable.

The internal voltage reference is a key source of noise in an LDO regulator. The TPS796xx-Q1 has an NR pin that is connected to the voltage reference through a 250-k Ω internal resistor. The 250-k Ω internal resistor, in conjunction with an external bypass capacitor connected to the NR pin, creates a low-pass filter to reduce the voltage reference noise and, therefore, the noise at the regulator output. In order for the regulator to operate properly, the current flow out of the NR pin must be at a minimum, because any leakage current creates an IR drop across the internal resistor, thus creating an output error. Therefore, the bypass capacitor must have minimal leakage current. The bypass capacitor should be no more than 0.1 μF in order to ensure that it is fully charged during the quickstart time provided by the internal switch shown in the [Functional Block Diagram](#).

For example, the TPS79630-Q1 exhibits 40 μV_{RMS} of output voltage noise using a 0.1- μF ceramic bypass capacitor and a 10- μF ceramic output capacitor. Note that the output starts up slower as the bypass capacitance increases because of the RC time constant at the bypass pin that is created by the internal 250-k Ω resistor and external capacitor.

Board Layout Recommendation to Improve PSRR and Noise Performance

To improve ac measurements such as PSRR, output noise, and transient response, it is recommended that the board be designed with separate ground planes for V_{IN} and V_{OUT} , with each ground plane connected only at the ground pin of the device. In addition, the ground connection for the bypass capacitor should connect directly to the ground pin of the device.

Regulator Mounting

The tab of the SOT223-6 package is electrically connected to ground. For best thermal performance, the tab of the surface-mount version should be soldered directly to the printed circuit board (PCB) copper area. Increasing the copper area improves heat dissipation.

Solder pad footprint recommendations for the devices are presented in an application bulletin *Solder Pad Recommendations for Surface-Mount Devices*, literature number [AB-132](#), available for download from the TI web site (www.ti.com).

Regulator Protection

The TPS796xx-Q1 PMOS-pass transistor has a built-in back diode that conducts reverse current when the input voltage drops below the output voltage (for example, during power-down). Current is conducted from the output to the input and is not internally limited. If extended reverse voltage operation is anticipated, external limiting might be appropriate.

The TPS796xx-Q1 features internal current limiting and thermal protection. During normal operation, the TPS796xx-Q1 limits output current to approximately 2.8 A. When current limiting engages, the output voltage scales back linearly until the overcurrent condition ends. While current limiting is designed to prevent gross device failure, care should be taken not to exceed the power dissipation ratings of the package. If the temperature of the device exceeds approximately +165°C, thermal-protection circuitry shuts it down. Once the device has cooled down to below approximately +140°C, regulator operation resumes.

THERMAL INFORMATION

POWER DISSIPATION

Knowing the device power dissipation and proper sizing of the thermal plane that is connected to the tab or pad is critical to avoiding thermal shutdown and ensuring reliable operation.

Power dissipation of the device depends on input voltage and load conditions and can be calculated using [Equation 1](#):

$$P_D = (V_{IN} - V_{OUT}) \times I_{OUT} \quad (1)$$

Power dissipation can be minimized and greater efficiency can be achieved by using the lowest possible input voltage necessary to achieve the required output voltage regulation.

On the SON (DRB) package, the primary conduction path for heat is through the exposed pad to the PCB. The pad can be connected to ground or be left floating; however, it should be attached to an appropriate amount of copper PCB area to ensure the device does not overheat. On the SOT-223 (DCQ) package, the primary conduction path for heat is through the tab to the PCB. That tab should be connected to ground. The maximum junction-to-ambient thermal resistance depends on the maximum ambient temperature, maximum device junction temperature, and power dissipation of the device and can be calculated using [Equation 2](#):

$$R_{\theta JA} = \frac{(+125^{\circ}\text{C} - T_A)}{P_D} \quad (2)$$

Knowing the maximum $R_{\theta JA}$, the minimum amount of PCB copper area needed for appropriate heatsinking can be estimated using [Figure 22](#).

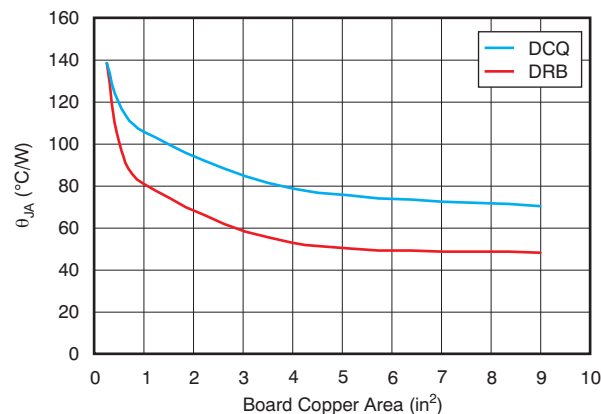

Note: θ_{JA} value at board size of 9 in² (that is, 3 in x 3 in) is a JEDEC standard.

Figure 22. θ_{JA} vs Board Size

[Figure 22](#) shows the variation of θ_{JA} as a function of ground plane copper area in the board. It is intended only as a guideline to demonstrate the effects of heat spreading in the ground plane and should not be used to estimate actual thermal performance in real application environments.

NOTE: When the device is mounted on an application PCB, it is strongly recommended to use Ψ_{JT} and Ψ_{JB} , as explained in the [Estimating Junction Temperature](#) section.

ESTIMATING JUNCTION TEMPERATURE

Using the thermal metrics Ψ_{JT} and Ψ_{JB} , as shown in the *Thermal Information* table, the junction temperature can be estimated with corresponding formulas (given in Equation 3). For backwards compatibility, an older $\theta_{JC, Top}$ parameter is listed as well.

$$\Psi_{JT}: T_J = T_T + \Psi_{JT} \cdot P_D$$

$$\Psi_{JB}: T_J = T_B + \Psi_{JB} \cdot P_D \quad (3)$$

Where P_D is the power dissipation shown by Equation 2, T_T is the temperature at the center-top of the IC package, and T_B is the PCB temperature measured 1 mm away from the IC package *on the PCB surface* (as Figure 24 shows).

NOTE: Both T_T and T_B can be measured on actual application boards using a thermo-gun (an infrared thermometer).

For more information about measuring T_T and T_B , see the application note [SBVA025](#), *Using New Thermal Metrics*, available for download at [www.ti.com](#).

By looking at Figure 23, the new thermal metrics (Ψ_{JT} and Ψ_{JB}) have very little dependency on board size. That is, using Ψ_{JT} or Ψ_{JB} with Equation 3 is a good way to estimate T_J by simply measuring T_T or T_B , regardless of the application board size.

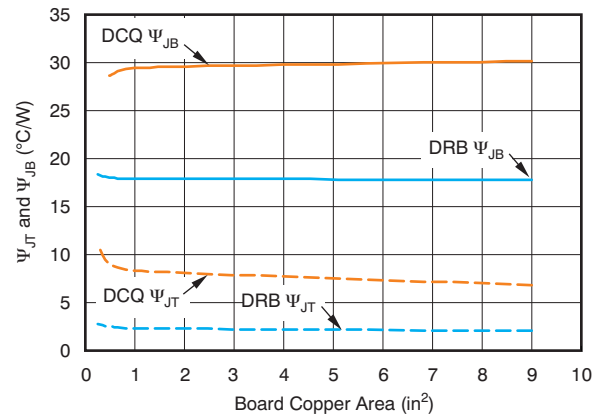
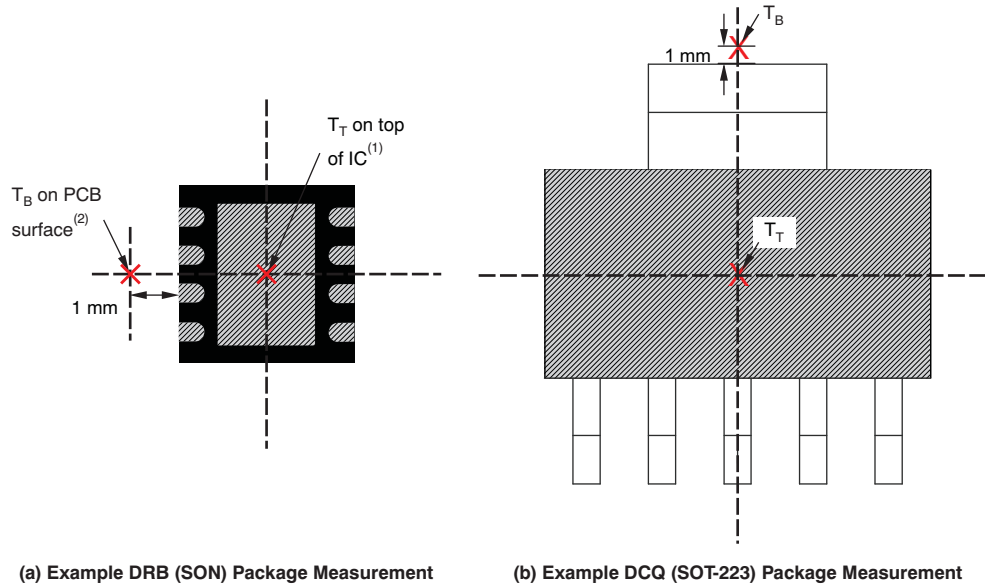

Figure 23. Ψ_{JT} and Ψ_{JB} vs Board Size

For a more detailed discussion of why TI does not recommend using $\theta_{JC(top)}$ to determine thermal characteristics, refer to application report [SBVA025](#), *Using New Thermal Metrics*, available for download at [www.ti.com](#). For further information, refer to application report [SPRA953](#), *IC Package Thermal Metrics*, also available on the TI website.



- (1) T_T is measured at the center of both the X- and Y-dimensional axes.
- (2) T_B is measured **below** the package lead on the PCB surface.

Figure 24. Measuring Points for T_T and T_B

PACKAGING INFORMATION

Orderable Device	Status (1)	Package Type	Package Drawing	Pins	Package Qty	Eco Plan (2)	Lead/Ball Finish	MSL Peak Temp (3)	Op Temp (°C)	Top-Side Markings (4)	Samples
TPS79633QDCQRQ1	ACTIVE	SOT-223	DCQ	6	2500	Green (RoHS & no Sb/Br)	CU NIPDAU	Level-3-260C-168 HR	-40 to 125	79633Q	Samples

(1) The marketing status values are defined as follows:

ACTIVE: Product device recommended for new designs.

LIFEBUY: TI has announced that the device will be discontinued, and a lifetime-buy period is in effect.

NRND: Not recommended for new designs. Device is in production to support existing customers, but TI does not recommend using this part in a new design.

PREVIEW: Device has been announced but is not in production. Samples may or may not be available.

OBSELETE: TI has discontinued the production of the device.

(2) Eco Plan - The planned eco-friendly classification: Pb-Free (RoHS), Pb-Free (RoHS Exempt), or Green (RoHS & no Sb/Br) - please check <http://www.ti.com/productcontent> for the latest availability information and additional product content details.

TBD: The Pb-Free/Green conversion plan has not been defined.

Pb-Free (RoHS): TI's terms "Lead-Free" or "Pb-Free" mean semiconductor products that are compatible with the current RoHS requirements for all 6 substances, including the requirement that lead not exceed 0.1% by weight in homogeneous materials. Where designed to be soldered at high temperatures, TI Pb-Free products are suitable for use in specified lead-free processes.

Pb-Free (RoHS Exempt): This component has a RoHS exemption for either 1) lead-based flip-chip solder bumps used between the die and package, or 2) lead-based die adhesive used between the die and leadframe. The component is otherwise considered Pb-Free (RoHS compatible) as defined above.

Green (RoHS & no Sb/Br): TI defines "Green" to mean Pb-Free (RoHS compatible), and free of Bromine (Br) and Antimony (Sb) based flame retardants (Br or Sb do not exceed 0.1% by weight in homogeneous material)

(3) MSL, Peak Temp. -- The Moisture Sensitivity Level rating according to the JEDEC industry standard classifications, and peak solder temperature.

(4) Multiple Top-Side Markings will be inside parentheses. Only one Top-Side Marking contained in parentheses and separated by a "~" will appear on a device. If a line is indented then it is a continuation of the previous line and the two combined represent the entire Top-Side Marking for that device.

Important Information and Disclaimer: The information provided on this page represents TI's knowledge and belief as of the date that it is provided. TI bases its knowledge and belief on information provided by third parties, and makes no representation or warranty as to the accuracy of such information. Efforts are underway to better integrate information from third parties. TI has taken and continues to take reasonable steps to provide representative and accurate information but may not have conducted destructive testing or chemical analysis on incoming materials and chemicals. TI and TI suppliers consider certain information to be proprietary, and thus CAS numbers and other limited information may not be available for release.

In no event shall TI's liability arising out of such information exceed the total purchase price of the TI part(s) at issue in this document sold by TI to Customer on an annual basis.

OTHER QUALIFIED VERSIONS OF TPS79633-Q1 :

- Catalog: [TPS79633](#)

NOTE: Qualified Version Definitions:

- Catalog - TI's standard catalog product

TAPE AND REEL INFORMATION

QUADRANT ASSIGNMENTS FOR PIN 1 ORIENTATION IN TAPE

*All dimensions are nominal

Device	Package Type	Package Drawing	Pins	SPQ	Reel Diameter (mm)	Reel Width W1 (mm)	A0 (mm)	B0 (mm)	K0 (mm)	P1 (mm)	W (mm)	Pin1 Quadrant
TPS79633QDCQRQ1	SOT-223	DCQ	6	2500	330.0	12.4	6.8	7.3	1.88	8.0	12.0	Q3

TAPE AND REEL BOX DIMENSIONS



*All dimensions are nominal

Device	Package Type	Package Drawing	Pins	SPQ	Length (mm)	Width (mm)	Height (mm)
TPS79633QDCQRQ1	SOT-223	DCQ	6	2500	346.0	346.0	29.0

DCQ (R-PDSO-G6)

PLASTIC SMALL-OUTLINE

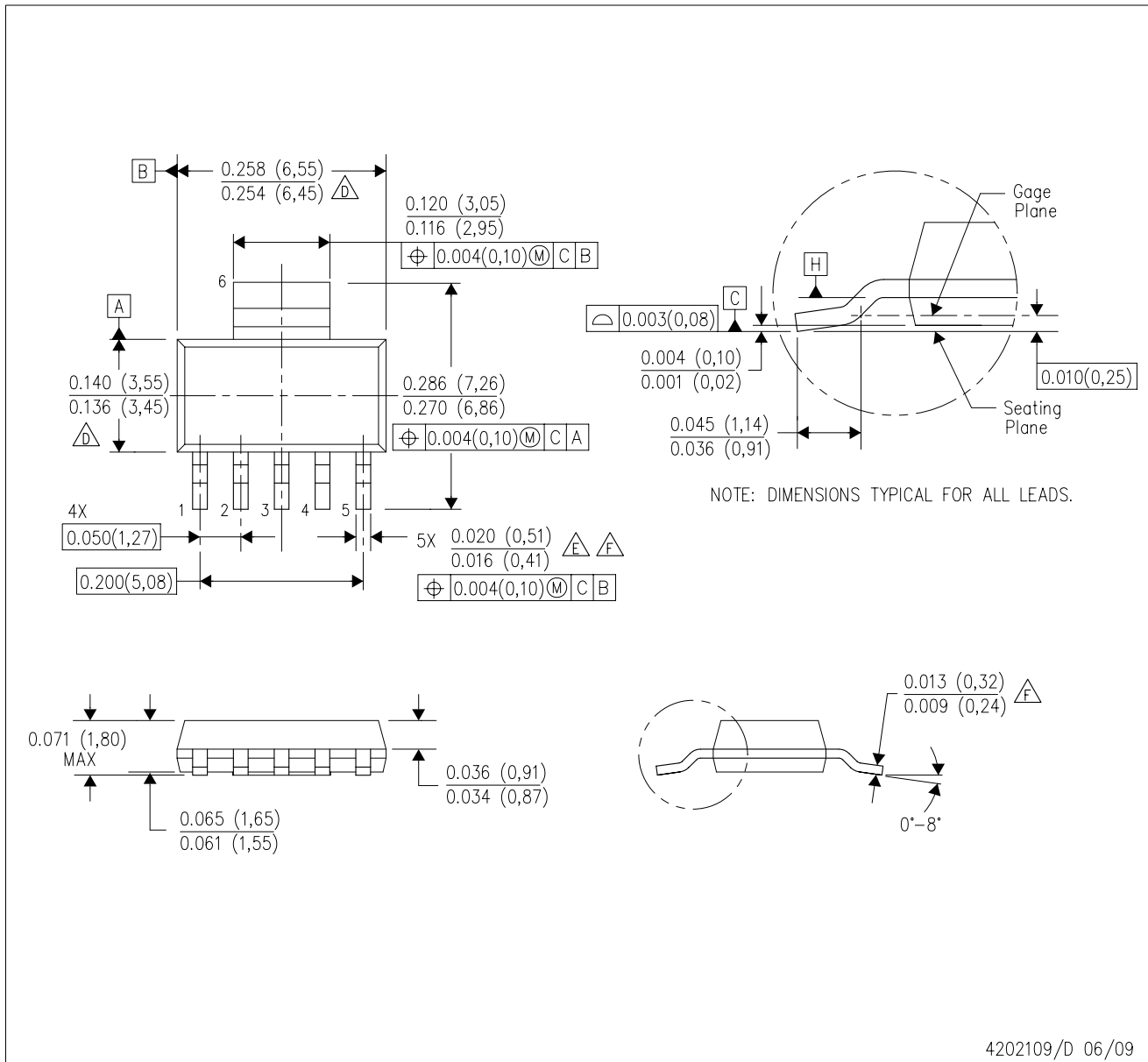

4202109/D 06/09

- NOTES:
- A. All linear dimensions are in inches (millimeters).
 - B. This drawing is subject to change without notice.
 - C. Controlling dimension in inches.
 - $\triangle D$ Body length and width dimensions are determined at the outermost extremes of the plastic body exclusive of mold flash, tie bar burrs, gate burrs, and interlead flash, but including any mismatch between the top and the bottom of the plastic body.
 - $\triangle E$ Lead width dimension does not include dambar protrusion.
 - $\triangle F$ Lead width and thickness dimensions apply to solder plated leads.
 - G. Interlead flash allow 0.008 inch max.
 - H. Gate burr/protrusion max. 0.006 inch.
 - I. Datums A and B are to be determined at Datum H.

DCQ (R-PDSO-G6)

PLASTIC SMALL OUTLINE

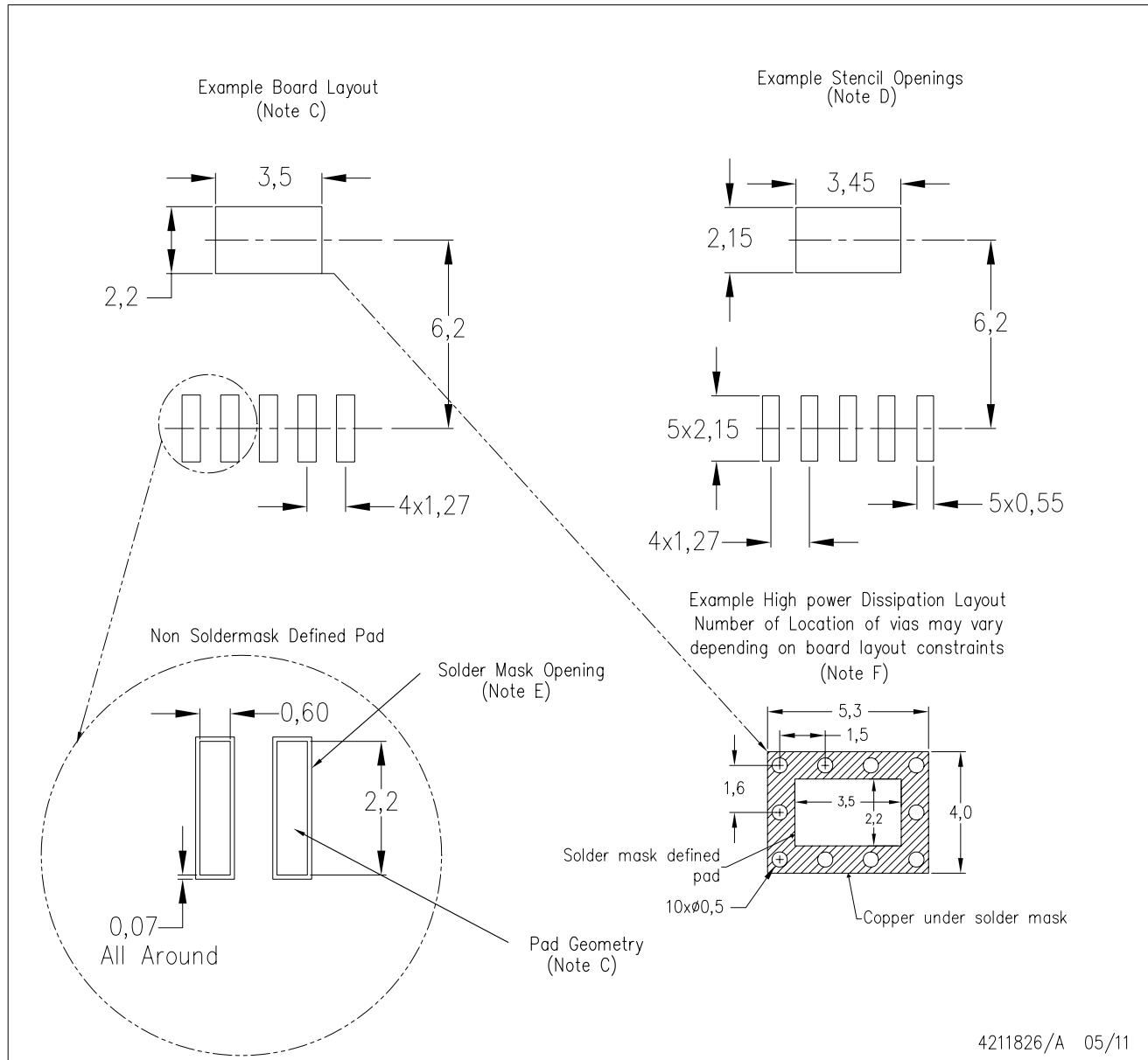

- NOTES:
- All linear dimensions are in millimeters.
 - This drawing is subject to change without notice.
 - Publication IPC-SM-782 is recommended for alternate designs.
 - Laser cutting apertures with trapezoidal walls and also rounding corners will offer better paste release. Customers should contact their board assembly site for stencil design recommendations.
 - Customers should contact their board fabrication site for solder mask tolerances between and around signal pads.
 - Please refer to the product data sheet for specific via and thermal dissipation requirements.

IMPORTANT NOTICE AND DISCLAIMER

TI PROVIDES TECHNICAL AND RELIABILITY DATA (INCLUDING DATASHEETS), DESIGN RESOURCES (INCLUDING REFERENCE DESIGNS), APPLICATION OR OTHER DESIGN ADVICE, WEB TOOLS, SAFETY INFORMATION, AND OTHER RESOURCES "AS IS" AND WITH ALL FAULTS, AND DISCLAIMS ALL WARRANTIES, EXPRESS AND IMPLIED, INCLUDING WITHOUT LIMITATION ANY IMPLIED WARRANTIES OF MERCHANTABILITY, FITNESS FOR A PARTICULAR PURPOSE OR NON-INFRINGEMENT OF THIRD PARTY INTELLECTUAL PROPERTY RIGHTS.

These resources are intended for skilled developers designing with TI products. You are solely responsible for (1) selecting the appropriate TI products for your application, (2) designing, validating and testing your application, and (3) ensuring your application meets applicable standards, and any other safety, security, or other requirements. These resources are subject to change without notice. TI grants you permission to use these resources only for development of an application that uses the TI products described in the resource. Other reproduction and display of these resources is prohibited. No license is granted to any other TI intellectual property right or to any third party intellectual property right. TI disclaims responsibility for, and you will fully indemnify TI and its representatives against, any claims, damages, costs, losses, and liabilities arising out of your use of these resources.

TI's products are provided subject to TI's Terms of Sale (www.ti.com/legal/termsofsale.html) or other applicable terms available either on ti.com or provided in conjunction with such TI products. TI's provision of these resources does not expand or otherwise alter TI's applicable warranties or warranty disclaimers for TI products.

Mailing Address: Texas Instruments, Post Office Box 655303, Dallas, Texas 75265
Copyright © 2018, Texas Instruments Incorporated